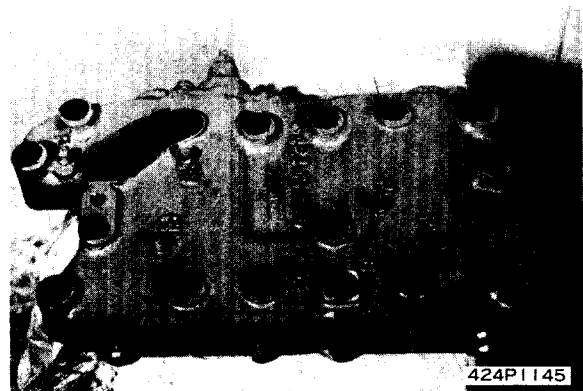

423F421

DISASSEMBLY OF UPPER VALVE

1. Remove covers (1) and (2).
2. Remove guide (3), then remove spring (4), shim (5), valves (6), (7) and (9), and spring (8) as a set.
3. Remove valves (10), (12) and (13), and spring (11).
4. Remove stopper (14), then remove quick return valve (15).
5. Remove spacer (16).
6. Remove snap ring (17), then remove guide (18).
7. Remove spring (19), shim (20), valves (21), (22) and (24), and spring (23) as a set.
8. Remove cover (25), valve (26), shim (27), and springs (28) and (29) as a set.
9. Remove cover (30).
10. Remove plug (31), then remove spacer (32).

**ASSEMBLY OF UPPER VALVE**

1. Assemble spacer (32) in body (33), fit O-ring and install plug (31).
2. Install cover (30).
3. Assemble shim (27), and springs (28) and (29) in valve (26), then assemble in body, fit O-ring and install cover (25).
4. Assemble valves (22) and (24), spring (23), shim (20) and spring (19) in valve (21), then assemble in body (33).
5. Install guide (18), then install snap ring (17).
6. Install spacer (16).
7. Assemble quick return valve (15), fit O-ring and install stopper (14).
8. Assemble valves (12) and (10), and spring (11) in valve (13), then install in body (33).
9. Assemble valves (9) and (7), spring (8), shim (5) and spring (4) in valve (6), then install guide (3).
10. Fit gaskets and install covers (2) and (1).

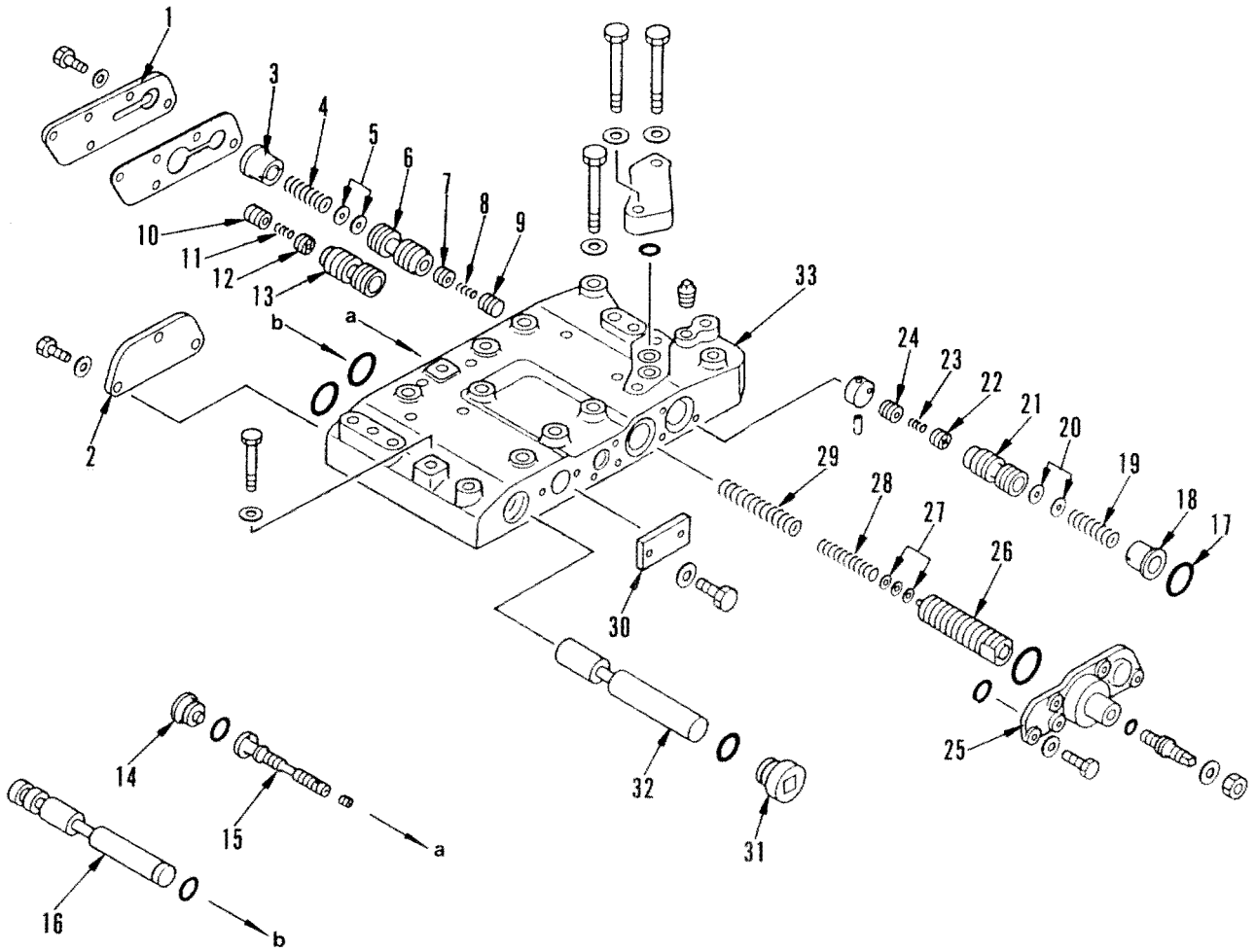

423F422

REMOVAL OF FRONT DIFFERENTIAL

Special tools

	Part number	Part name	Q'ty
A	793-520-2410	Bracket	1
B	793-520-2510	Bracket	1

 Stop the machine on level ground and install the safety bar on the frame. Lower the bucket to the ground and stop the engine. Then apply the parking brake and put blocks under the wheels to prevent the machine from moving.

1. Draining oil

Remove drain plug (1) and drain oil from axle assembly.

 Axle assembly: **Approx. 62 ℓ**

2. Tire, wheel

- 1) Using lift arm, raise front axle, then put stand under left housing and put block ① under front frame.
- 2) Sling left tire and wheel (2), remove mounting bolts, then lift off.

 Tire, wheel: **458 kg**

3. Covers

Remove left and right covers (3).

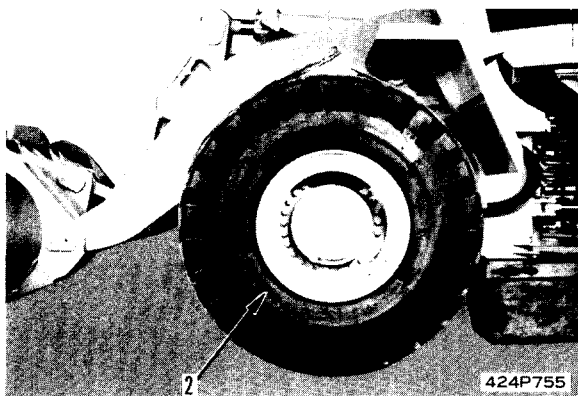
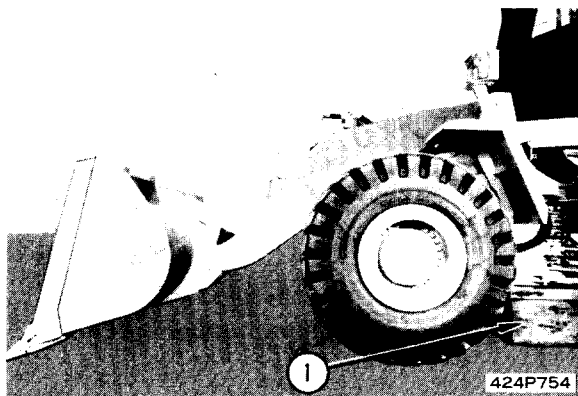
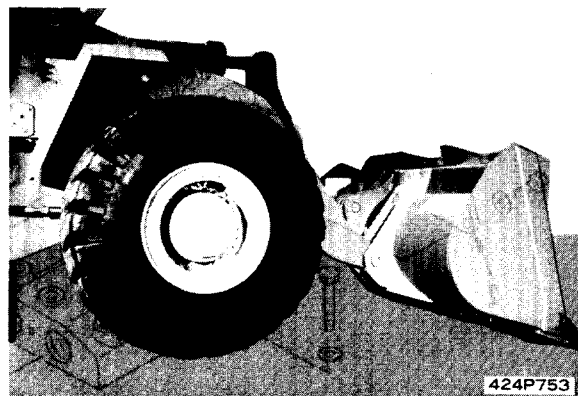
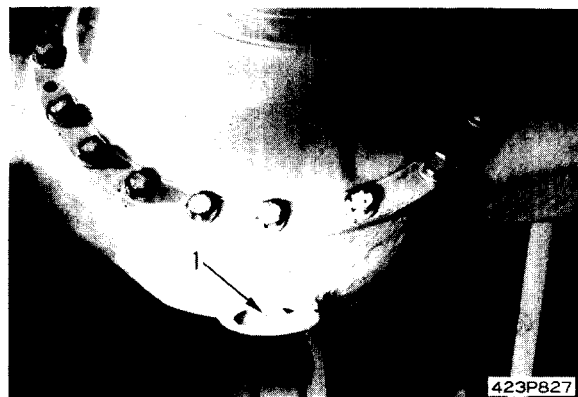
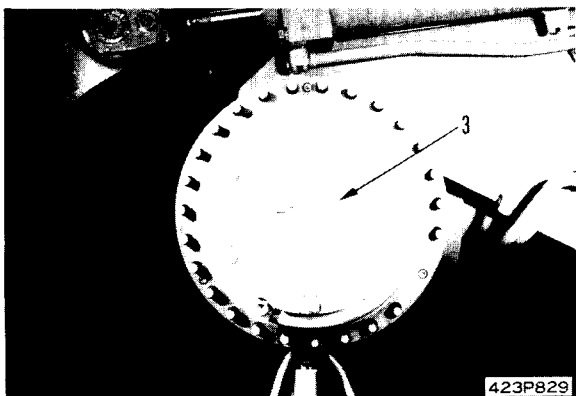

4. Axle shaft

Using forcing screw, pull out axle shaft (4) and sun gear (5) about 200 mm.

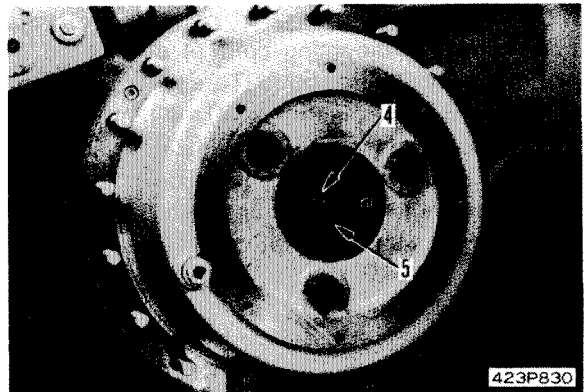
**5. Drive shaft**

- 1) Disconnect grease tube (6).
- 2) Disconnect front drive shaft (7) at differential and at center.
- 3) Remove flange bearing (8), then move front drive shaft towards rear frame.

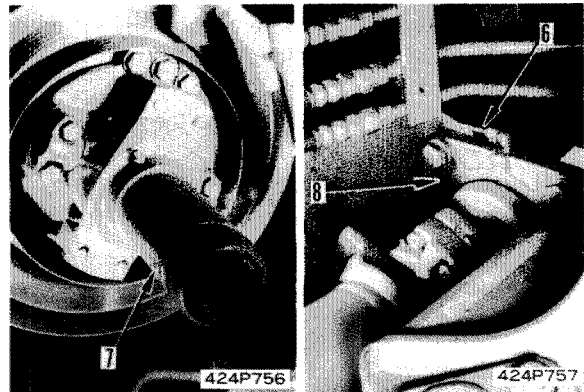
**6. Parking brake**

- 1) Release parking brake, then disconnect lever (9) of linkage.
- 2) Remove parking brake caliper (10).

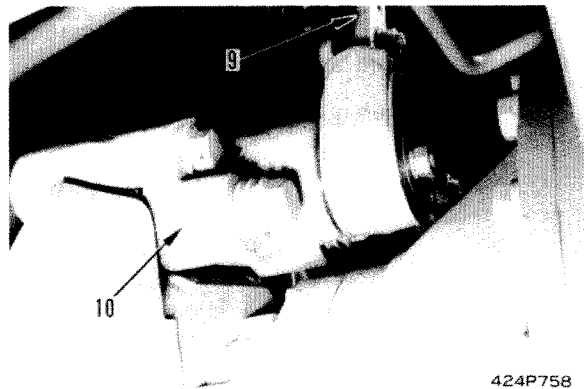
**7. Hydraulic piping**

Remove lift cylinder tube (11) from brackets (12) on left and right of front frame, and bracket (13) inside front frame, then move it towards rear frame.

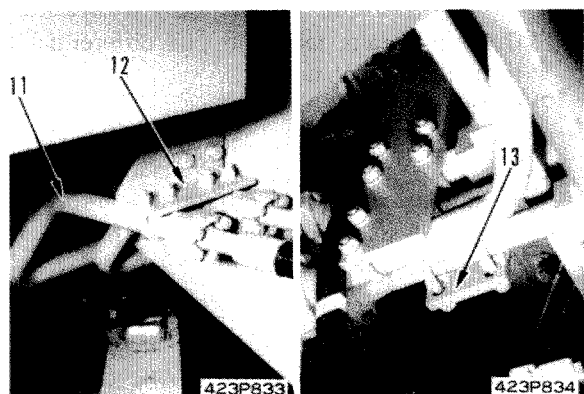

8. Differential

- 1) Remove 2 mounting bolts of differential (14), then install guide bolts (Thread dia. = 14 mm, pitch = 2 mm, length = 50 mm).
 - ★ Screw the thread of the guide bolts in fully.
 - ★ After screwing in the guide bolts, remove the remaining mounting bolts.
- 2) Fit lifting tool ② to differential case (15).

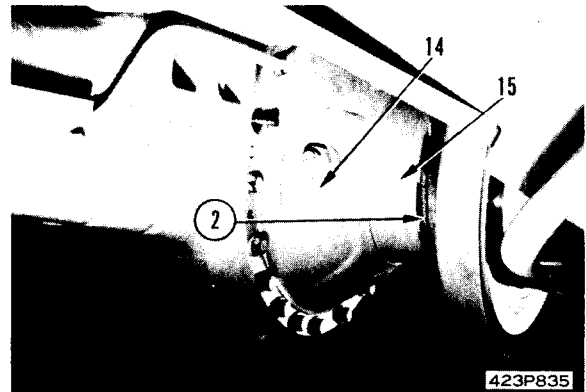

- 3) Install forcing screw, and pull out differential (14) along guide bolts about 20 mm from axle housing (16).
 - ★ Be careful not to damage the differential O-ring.
- 4) Install tools A and B to garage jack, then insert between differential and axle housing, and install tool A to differential.

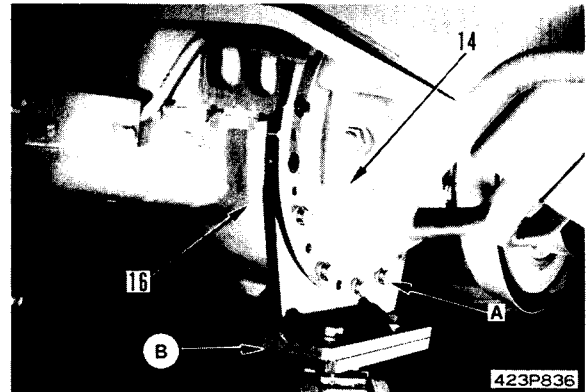

- 5) Adjust height of lifting tool and garage jack, and remove differential (14) carefully.



Differential: **210 kg**

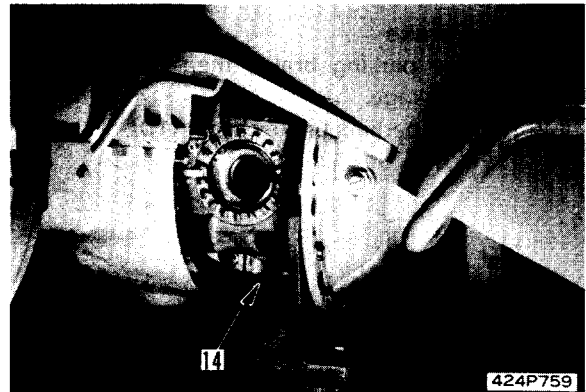

- 6) Operate garage jack and pull differential out from under machine body.
- 7) Remove O-ring (17).

- ★ To remove the rear differential, first remove the axle assembly, then remove the differential from the axle.

